

power light source

# LUXEON® K2 with TFFC

## Introduction

LUXEON® K2 with TFFC is the most robust and powerful LED available offering the lowest cost of light with the widest operating range of any power LED.

## LUXEON K2 with TFFC

- ♦ delivers more useable light
- ♦ optimizes applications to reduce size and cost
- ♦ enables more robust applications
- ♦ reduces thermal management engineering
- ♦ enables use of standard FR4 PCB technology
- ♦ simplifies manufacturing through the use of surface mount technology.

## Technology Leadership

- ♦ Industry leading lumen performance, over 220 lumens at 1000mA
- ♦ Over 60 lm/W at 1000mA
- ♦ Highest operating junction temperature available, up to 150°C
- ♦ Highest Drive Currents—1500 mA
- ♦ Lowest Thermal Resistance—5.5°C/W
- ♦ Industry Best Moisture Sensitivity level—JEDEC 2a
- ♦ Lead free reflow solder JEDEC 020c compatible
- ♦ RoHS and REACH Compliant
- ♦ Autoclave compliant—JESD22 A-102
- ♦ Industry Best Lumen Maintenance—50,000 hours life at 1000 mA with greater than 70% lumen maintenance

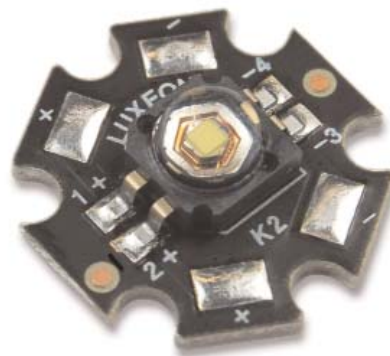
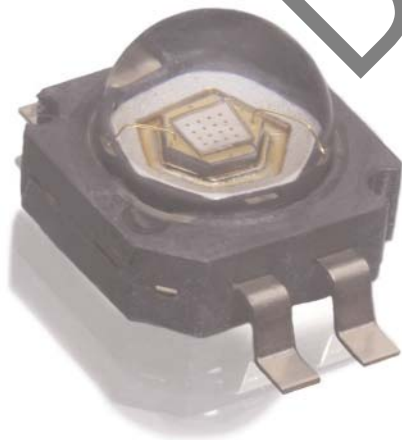

---

## Table of Contents

Product Nomenclature . . . . .	.3
Average Lumen Maintenance Characteristics . . . . .	.3
Environmental Compliance . . . . .	.3
Flux Characteristics for LUXEON K2 with TFFC . . . . .	.4
Flux Characteristics for LUXEON K2 with TFFC Star . . . . .	.4
Flux Performance, Binning, and Supportability . . . . .	.5
Optical Characteristics . . . . .	.5
Electrical Characteristics . . . . .	.6
Absolute Maximum Ratings . . . . .	.7
JEDEC Moisture Sensitivity . . . . .	.8
Reflow Soldering Characteristics . . . . .	.8
Mechanical Dimensions—SMT 4-Lead Gullwing Form . . . . .	.9
Solder Pad Layout—SMT Lead Form . . . . .	.10
Mechanical Dimensions— LUXEON K2 with TFFC Star . . . . .	.11
Wavelength Characteristics . . . . .	.12
Typical Light Output Characteristics Over Temperature . . . . .	.13
Typical Forward Current Characteristics . . . . .	.14
Typical Relative Luminous Flux . . . . .	.14
Current Derating Curves . . . . .	.15
Typical Radiation Patterns . . . . .	.17
Emitter Reel Packaging . . . . .	.18
Product Binning and Labeling . . . . .	.19
Luminous Flux Bins . . . . .	.20
Forward Voltage Bins . . . . .	.21
White Binning Information . . . . .	.22
LUXEON K2 with TFFC Cool-White Bin Structure . . . . .	.23
LUXEON K2 with TFFC Neutral-White Bin Structure . . . . .	.25
LUXEON K2 with TFFC Warm-White Bin Structure . . . . .	.26

---

## Product Nomenclature

LUXEON K2 with TFFC LEDs are tested and binned at 1000mA.

The part number designation is explained as follows:

L X K 2 - A B C D - E F G H for Emitter  
L 2 K 2 - A B C D - x x - E F G H for Star

Where:

A — designates radiation pattern (Value P for Lambertian emitter, M for Lambertian Star product)  
B — designates color  
C — designates color variant (0 for direct colors, C for Cool-White, N for Neutral-White, W for Warm-White)  
D — designates test current (value 4 for 1000 mA)  
E — Reserved for future offerings  
FGH — minimum luminous flux (lm) or radiometric power (mW) performance

x x - indicates array description for Level 2 Star Product (11 for 1x1 array)

Therefore, products tested and binned at 1000mA follow the part numbering scheme:

L X K 2 - P x x 4 - x x x x (L 2 K 2 - M x x 4 - 1 1 - x x x x for Star)

## Average Lumen Maintenance Characteristics

Lifetime for solid-state lighting devices (LEDs) is typically defined in terms of lumen maintenance—the percentage of initial light output remaining after a specified period of time.

Philips Lumileds projects that white LUXEON K2 with TFFC products will deliver, on average, 70% lumen maintenance at 50,000 hours of operation at a forward current of 1000mA. This projection is based on constant current operation with junction temperature maintained at or below 120°C.

This performance is based on independent test data, Philips Lumileds historical data from tests run on similar material systems, and internal LUXEON reliability testing. Observation of design limits included in this data sheet is required in order to achieve this projected lumen maintenance.

More information about lifetime and reliability can be found in the LUXEON K2 Reliability Datasheet on the Philips Lumileds web site.

## Environmental Compliance

Philips Lumileds is committed to providing environmentally friendly products to the solid-state lighting market. LUXEON K2 with TFFC LEDs are compliant to the European Union directives on the Restriction of Hazardous Substances in electronic equipment, namely the RoHS directive. Philips Lumileds will not intentionally add the following restricted materials to LUXEON K2 with TFFC LEDs: lead, mercury, cadmium, hexavalent chromium, polybrominated biphenyls (PBB) or polybrominated diphenyl ethers (PBDE).

## Flux Characteristics for LUXEON K2 with TFFC Junction and Case Temperature = 25°C

Table 1.

Minimum Performance at Test Current			Typical Performance at Indicated Current		
Color	Part Number	Minimum Luminous Flux (lm)	Typical Luminous Flux (lm)		
		at 1000mA	at 1500 mA	at 700 mA	at 350 mA
Cool-White	LXK2-PWC4-0220	220	300	185	105
	LXK2-PWC4-0200	200	275	170	95
	LXK2-PWC4-0180	180	250	150	85
	LXK2-PWC4-0160	160	220	135	75
Neutral-White	LXK2-PWN4-0200	200	275	170	95
	LXK2-PWN4-0180	180	250	150	85
	LXK2-PWN4-0160	160	220	135	75
	LXK2-PWN4-0140	140	195	120	65
Warm-White	LXK2-PWW4-0180	180	250	150	85
	LXK2-PWW4-0160	160	220	135	75
	LXK2-PWW4-0140	140	195	120	65
	LXK2-PWW4-0120	120	170	105	55

## Flux Characteristics for LUXEON K2 with TFFC Star Junction and Case Temperature = 25°C

Table 2.

Minimum Performance at Test Current			Typical Performance at Indicated Current		
Color	Part Number	Minimum Luminous Flux (lm)	Typical Luminous Flux (lm)		
		at 1000mA	at 1500 mA	at 700 mA	at 350 mA
Cool-White	L2K2-MWC4-11-0220	220	300	185	105
	L2K2-MWC4-11-0200	200	275	170	95
	L2K2-MWC4-11-0180	180	250	150	85
	L2K2-MWC4-11-0160	160	220	135	75
Neutral-White	L2K2-MWN4-11-0200	200	275	170	95
	L2K2-MWN4-11-0180	180	250	150	85
	L2K2-MWN4-11-0160	160	220	135	75
	L2K2-MWN4-11-0140	140	195	120	65
Warm-White	L2K2-MWW4-11-0180	180	250	150	85
	L2K2-MWW4-11-0160	160	220	135	75
	L2K2-MWW4-11-0140	140	195	120	65
	L2K2-MWW4-11-0120	120	170	105	55

Notes for Tables 1 & 2:

- Minimum luminous flux performance guaranteed within published operating conditions. Philips Lumileds maintains a tolerance of  $\pm 10\%$  on flux and power measurements of LUXEON K2 with TFFC.
- Typical luminous flux performance when device is operated within published operating conditions.
- Radiation Pattern for all LUXEON K2 with TFFC products is Lambertian.
- LUXEON K2 with TFFC is tested and binned at 25°C with a 20ms monopulse test to minimize heating of the junction or case.
- Case Temperature should be measured in the center of the bottom of heatsink slug.

## Flux Performance, Binning, and Supportability

LEDs are produced with semiconductor technology that is subject to process variation, yielding a range of flux performance that is approximately Gaussian in nature. In order to provide customers with fine granularity within the overall flux distribution, Philips Lumileds separates LEDs into fixed, easy to design with, minimum luminous flux bins. To verify supportability of parts chosen for your application design, please consult your Philips Lumileds/Future Lighting Solutions sales representative.

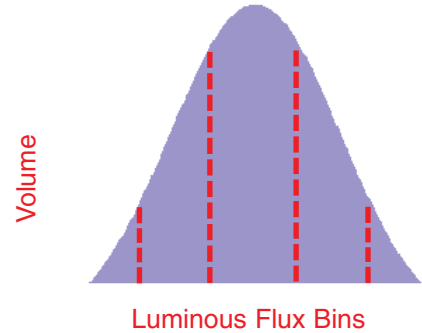

## Optical Characteristics

### LUXEON K2 with TFFC at Test Current<sup>[1]</sup> Junction and Case Temperature = 25°C<sup>[11]</sup>

Table 3.

Color	Dominant Wavelength <sup>[2]</sup> $\lambda_D$ , Peak Wavelength <sup>[3]</sup> $\lambda_P$ , or Color Temperature <sup>[4]</sup> CCT			Typical Spectral Half-width <sup>[6]</sup> (nm) $\Delta\lambda_{1/2}$	Typical Temperature Coefficient of Dominant Wavelength (nm/°C) $\Delta\lambda_D / \Delta T_J$	Typical Total Included Angle <sup>[7]</sup> (degrees) $\theta_{0.90V}$	Typical Viewing Angle <sup>[8]</sup> (degrees) $2\theta_{1/2}$
	Min.	Typ.	Max.				
Cool White	4500 K	6500 K	10000 K	-	-	160	120
Neutral White	3500K	4100K	4500K	-	-	160	120
Warm White	2670K	3000K	3500K	-	-	160	120

Notes for Table 3:

1. Test current is 1000 mA for all LXX2 - Pxx4 - xxxx Emitter products (L2K2 - Mxx4 - 11 - xxxx for LUXEON K2 with TFFC Star products).
2. Dominant wavelength is derived from the CIE 1931 Chromaticity diagram and represents the perceived color. Philips Lumileds maintains a tolerance of  $\pm 0.5$  nm for dominant wavelength measurements.
3. Philips Lumileds maintains a tolerance of  $\pm 2$  nm for peak wavelength measurements.
4. CCT  $\pm 5\%$  tester tolerance
5. Typical CRI (Color Rendering Index) for Cool-White and Neutral-White products is 70, and for Warm-White product is 75.
6. Spectral width at  $1/2$  of the peak intensity.
7. Total angle at which 90% of total luminous flux is captured.
8. Viewing angle is the off axis angle from lamp centerline where the luminous intensity is  $1/2$  of the peak value.
9. All white products are built with Indium Gallium Nitride (InGaN).
10. White power light sources represented here are IEC60825 class 2 for eye safety.
11. LUXEON K2 with TFFC is tested and binned at 25°C with a 20ms monopulse test to minimize heating of the junction or case.

## Electrical Characteristics

### Electrical Characteristics at 1000mA Junction and Case Temperature = 25°C<sup>[4]</sup>

Table 4.

Color	Forward Voltage $V_f$ <sup>[1]</sup> (V)			Typical Dynamic Resistance <sup>[2]</sup> ( $\Omega$ ) $R_D$	Typical Temperature Coefficient of Forward Voltage (mV/°C) $\Delta V_F / \Delta T_J$	Typical Thermal Resistance Junction to Case (°C/W) $R\theta_{J-C}$
	Min.	Typ.	Max.			
Cool-White <sup>[3]</sup>	3.03	3.65	4.71	0.45	-2.8	5.5 (9.5 for Star)
Neutral-White	3.03	3.65	4.71	.45	-2.8	5.5 (9.5 for Star)
Warm-White	3.03	3.65	4.71	.45	-2.8	5.5 (9.5 for Star)

Notes for Table 4:

1. Philips Lumileds maintains a tolerance of  $\pm 0.06V$  on forward voltage measurements.
2. Dynamic resistance is the inverse of the slope in linear forward voltage model for LEDs. See figure 13.
3. The forward voltage of the LUXEON K2 with TFFC LED will reduce by up to 0.50V at 1000mA during the first few hours of operation after SMT reflow. Due to this effect, Philips Lumileds recommends current source drive for consistent and reliable performance. Cross connected series/parallel arrays or voltage drivers which could result in current hogging or variation in drive current are not recommended. Please consult your Future Lighting Solutions or Philips Lumileds account manager for further information.
4. LUXEON K2 with TFFC is tested and binned at 25°C with a 20ms monopulse test to minimize heating of the junction or case.

### Typical Electrical Characteristics Junction and Case Temperature = 25°C

Table 5.

Color	Typical Forward Voltage $V_f$ (V)		
	at 1500mA	at 700mA	at 350mA
Cool-White	3.85	3.5	3.3
Neutral-White	3.85	3.5	3.3
Warm-White	3.85	3.5	3.3

## Absolute Maximum Ratings<sup>[3]</sup>

Table 6.

Parameter	Cool-White/Neutral-White/Warm-White Value
DC Forward Current (mA)	1500
Peak Pulsed Forward Current (mA)	1500
Average Forward Current (mA)	1500
ESD Sensitivity	> 2,000 V HBM Class 2 JESD22-A114-B
LED Junction Temperature <sup>[1]</sup>	150°C
Storage Temperature	-40°C - 185°C
Soldering Temperature	JEDEC 020c 260°C
Allowable Reflow Cycles	3
Autoclave Conditions	121°C at 2 ATM, 100% RH for 72 hours max
Reverse Voltage (Vr)	See Note 2

Notes for Table 6:

1. Proper current derating and thermal management must be observed to maintain junction temperature below the maximum.
2. LEDs are not designed to be driven in reverse bias.
3. Stresses in excess of the absolute maximum ratings can cause damage to the emitter. Maximum Rating limits apply to each parameter in isolation, all parameters having values within the Current Derating Curve. It should not be assumed that limiting values of more than one parameter can be applied to the product at the same time. Exposures to the absolute maximum ratings for extended periods can adversely affect device reliability.

# JEDEC Moisture Sensitivity

Table 7.

Level	Soak Requirements					
	Floor Life		Standard		Accelerated Environment	
	Time	Conditions	Time (hours)	Conditions	Time (hours)	Conditions
2a	4 weeks	≤ 30°C / 60% RH	696 <sup>(1)</sup> + 5/-0	30°C / 60% RH	120 +1/-0	60°C / 60% RH

Note for Table 7:

- The standard soak time includes a default value of 24 hours for semiconductor manufacturer's exposure time (MET) between bake and bag and includes the maximum time allowed out of the bag at the distributor's facility.

## Reflow Soldering Characteristics<sup>[1]</sup>

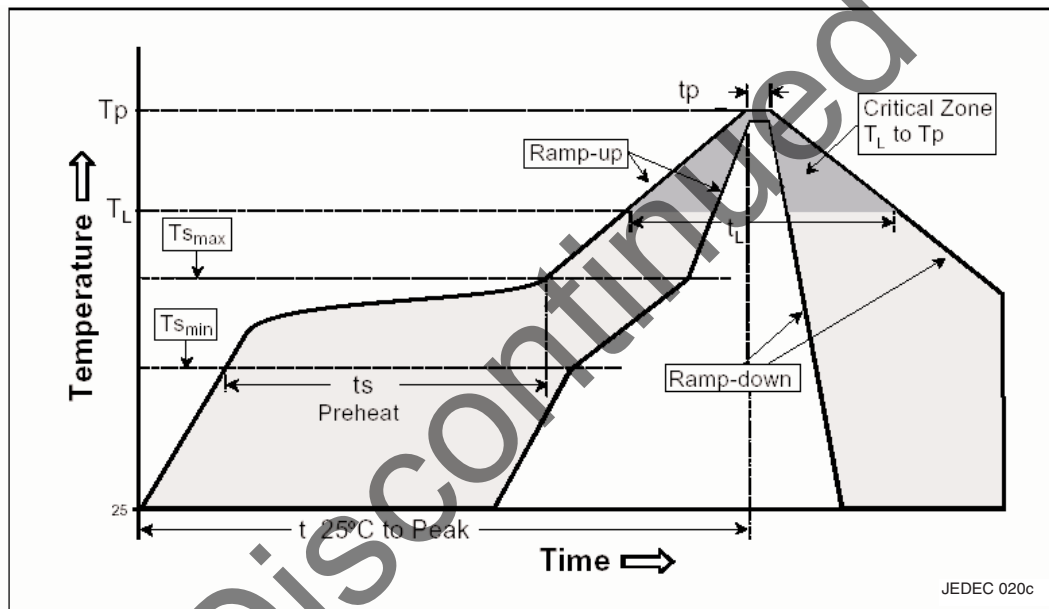

Table 8.

Profile Feature	Lead Free Assembly
Average Ramp-Up Rate (Ts <sub>max</sub> to Tp)	3°C / second max
Preheat Temperature Min (Ts <sub>min</sub> )	150°C
Preheat Temperature Max (Ts <sub>max</sub> )	200°C
Preheat Time (ts <sub>min</sub> to ts <sub>max</sub> )	60 - 180 seconds
Temperature (T <sub>l</sub> )	217°C
Time Maintained Above Temperature (T <sub>l</sub> )	60 - 150 seconds
Peak / Classification Temperature (T <sub>p</sub> )	260°C
Time Within 5°C of Actual Peak Temperature (T <sub>p</sub> )	20 - 40 seconds
Ramp - Down Rate	6°C / second max
Time 25°C to Peak Temperature	8 minutes max

Notes for Table 8:

- All temperatures refer to topside of the package, measured on the package body surface.



## Mechanical Dimensions—SMT 4-Lead Gullwing Form

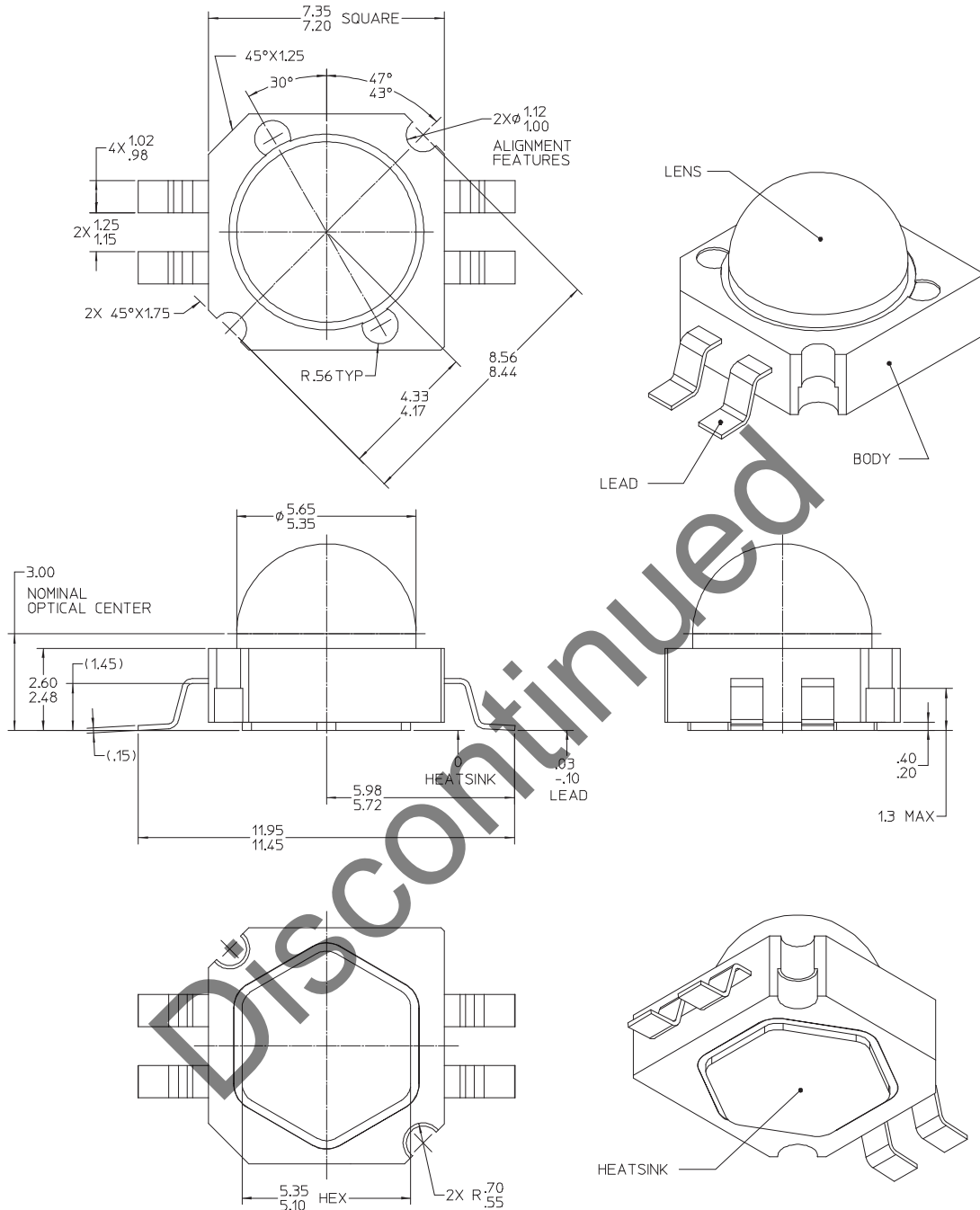

Figure 1. 4-lead Gullwing Package Outline Drawing.

Notes for Figure 1:

1. The anode side of the device is denoted by the chamfer on the part body. Electrical insulation between the case and the board is required—slug of the device is not electrically neutral. Do not electrically connect either the anode or cathode to the slug.
2. Do not handle the device by the lens except as described in Philips Lumileds document AB29.
3. Drawings not to scale.
4. All dimensions are in millimeters.
5. All dimensions without tolerances are for reference only.
6. Recommended solder paste thickness of 0.15mm.
7. 2-Lead Gullwing configuration also available. Please contact your Philips Lumileds representative for more information.

## Solder Pad Design—SMT Lead Form

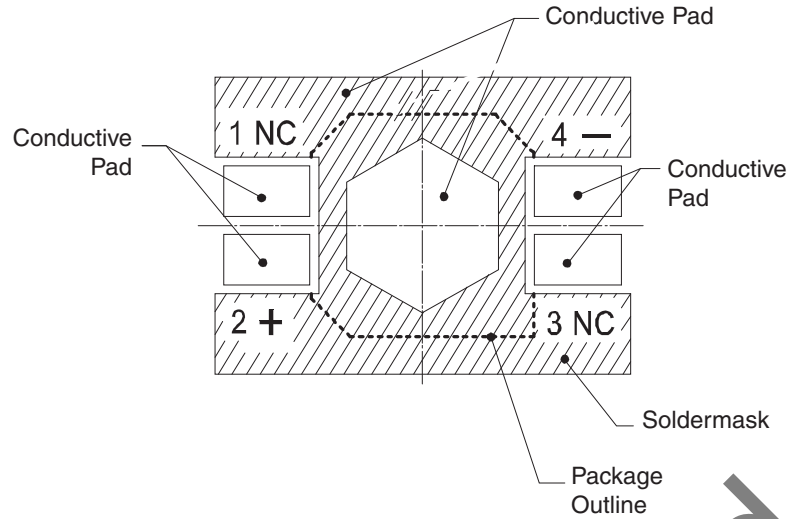

Figure 2. 4-Lead Gullwing Solder Pad Design.

Notes for Figure 2:

1. Electrical isolation is required between signal leads and hexagonal heat slug contact.
2. For optimal thermal performance, maximize board metallization at hexagonal heat slug contact.

## Solder Pad Layout—SMT Lead Form

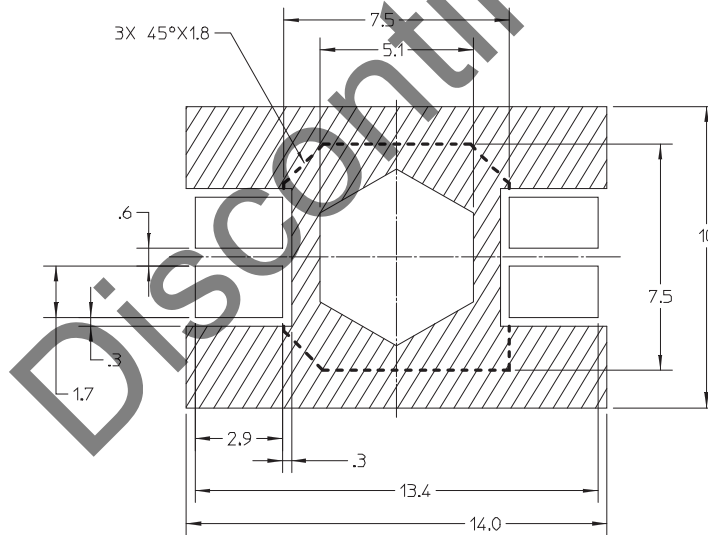

Figure 3. 4-Lead Gullwing Package Solder Pad Layout.

## Pin Out Diagram

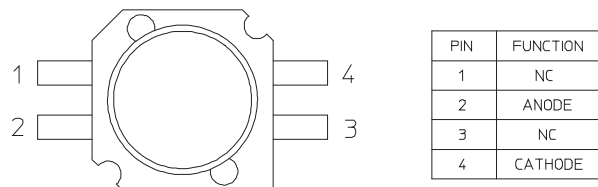

Figure 4. 4-Lead Gullwing Pin Out Diagram.

## Mechanical Dimensions— LUXEON K2 with TFFC Star

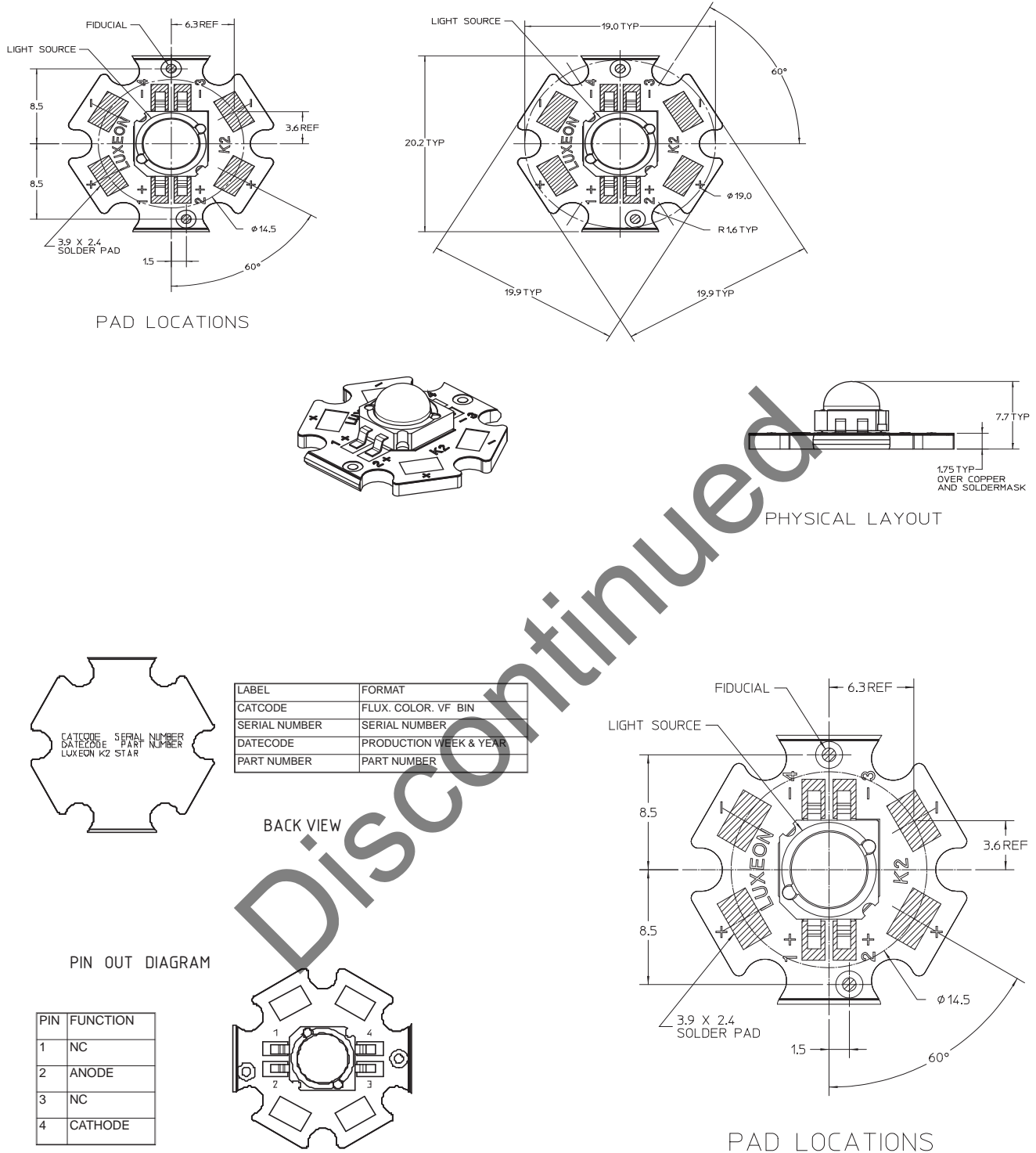

Figure 5. LUXEON K2 with TFFC Star Package Outline Drawing.

Notes for Figure 5:

1. Slots in aluminum core PCB for M3 or #4 mounting screw.
2. Electrical interconnection pads labeled on the aluminum core PCB with "+" and "-" to denote positive and negative, respectively. All positive pads are interconnected, as are all negative pads, allowing for flexibility in array interconnection.
3. Drawings not to scale.
4. All dimensions are in millimeters.

## Wavelength Characteristics

### Cool-White at Test Current Junction and Case Temperature = 25°C

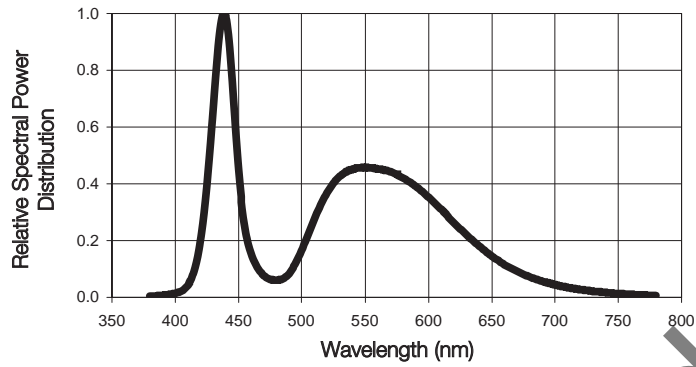

Figure 6a. Cool-White color spectrum of typical CCT part, integrated measurement.

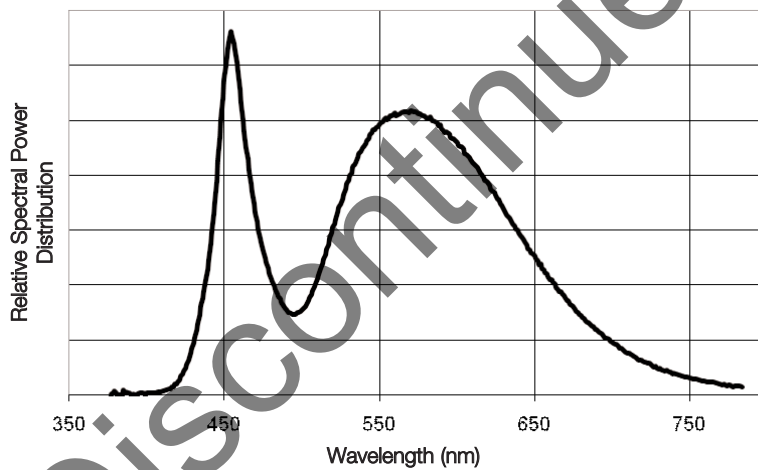

Figure 6b. Neutral-White color spectrum of typical CCT part, integrated measurement.

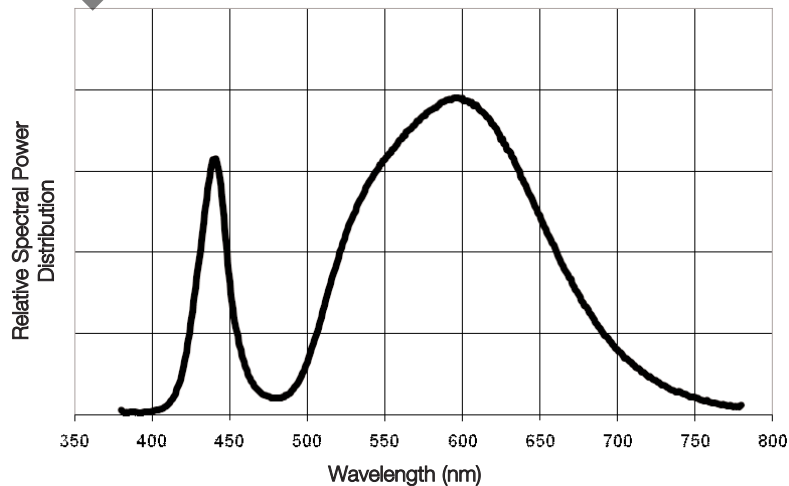

Figure 6c. Warm-White color spectrum of typical CCT part, integrated measurement.

## Typical Light Output Characteristics Over Temperature

Cool-White, Neutral-White, and Warm-White at Test Current

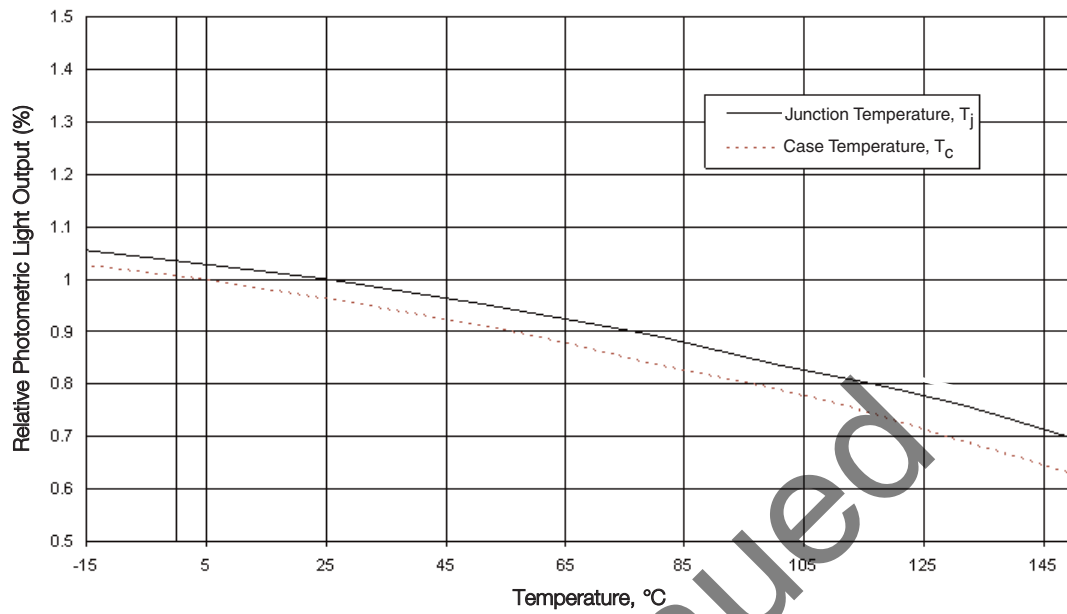

Figure 7. Relative light output vs. temperature for white.

## Typical Forward Current Characteristics Junction and Case Temperature = 25°C

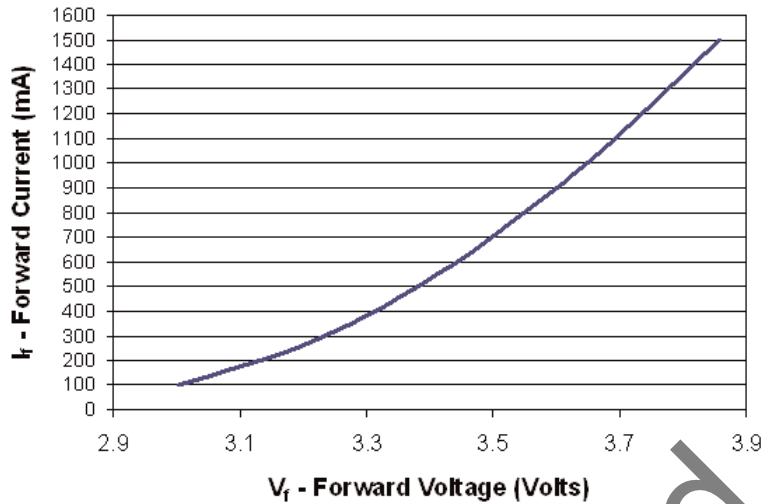

Figure 8. Forward current vs. forward voltage for white.

## Typical Relative Luminous Flux

### Relative Luminous Flux vs. Forward Current Junction and Case Temperature = 25°C

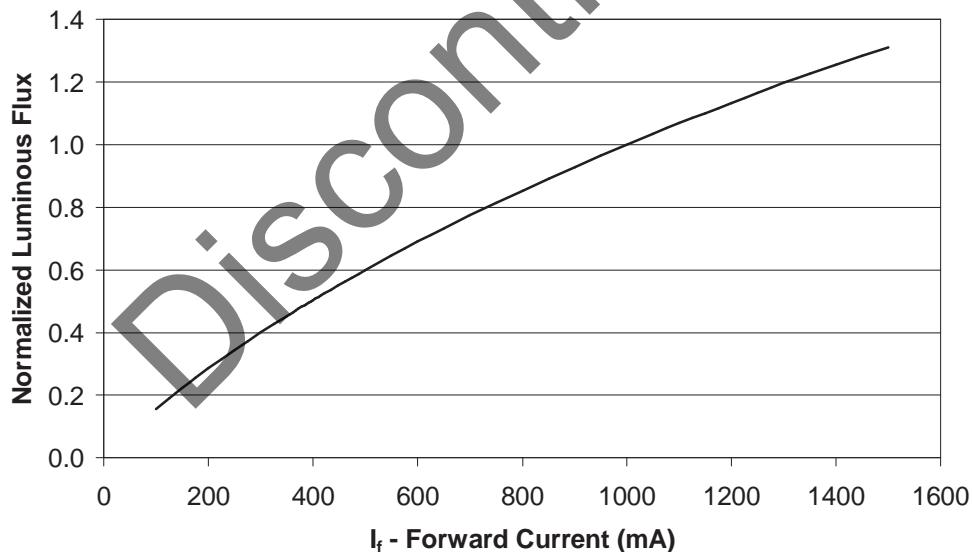

Figure 9. Relative luminous flux or radiometric power vs. forward current for white at 20ms monopulse, test current 1000 mA.

Notes for Figures 8 and 9:

1. Driving these high power devices at currents other than the test condition (1000 mA) may be subject to variation in performance.
2. It is not recommended to operate these devices at less than 100mA drive currents. Pulse width modulation (PWM) is recommended for dimming effects.
3. LUXEON K2 with TFFC is tested and binned at 25°C with a 20ms monopulse test to minimize heating of the junction or case.

## Current Derating Curves

Note: Current derating curves are intended to represent the operational limits of the product as identified in Table 6. For lumen maintenance information and conditions, please refer to the Average Lumen Maintenance Characteristics section in this document.

### Current Derating Curve for 1500 mA Drive Current Cool-White, Neutral-White, Warm-White

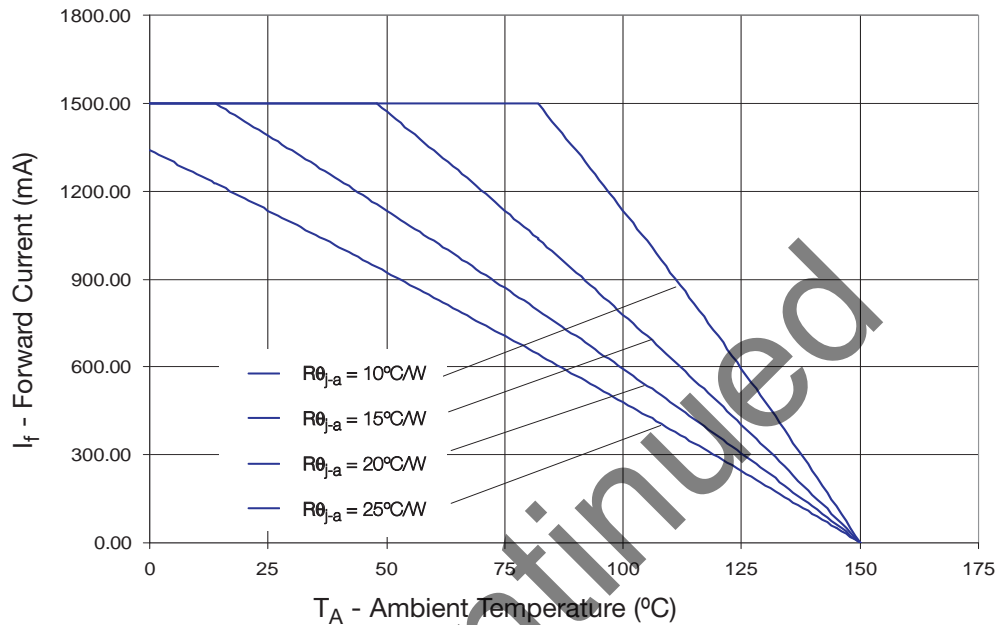

Figure 10: Maximum forward current vs. ambient temperature, based on  $T_{JMAX} = 150^{\circ}\text{C}$ .

### Current Derating Curve for 1000 mA Drive Current Cool-White, Neutral-White, Warm-White

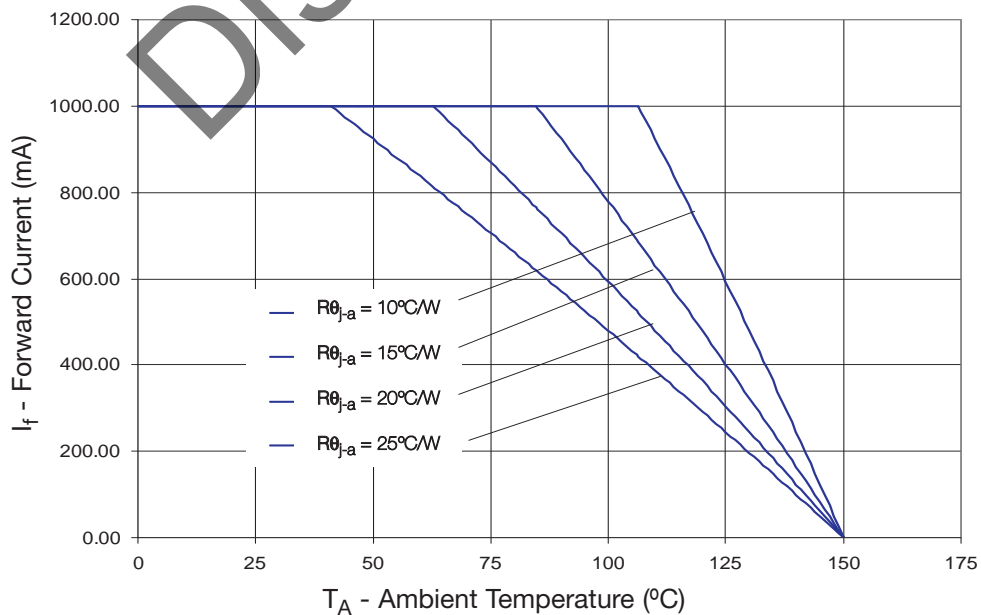

Figure 11: Maximum forward current vs. ambient temperature, based on  $T_{JMAX} = 150^{\circ}\text{C}$ .

## Current Derating Curves, Continued

### Current Derating Curve for 700 mA Drive Current Cool-White, Neutral-White, Warm-White

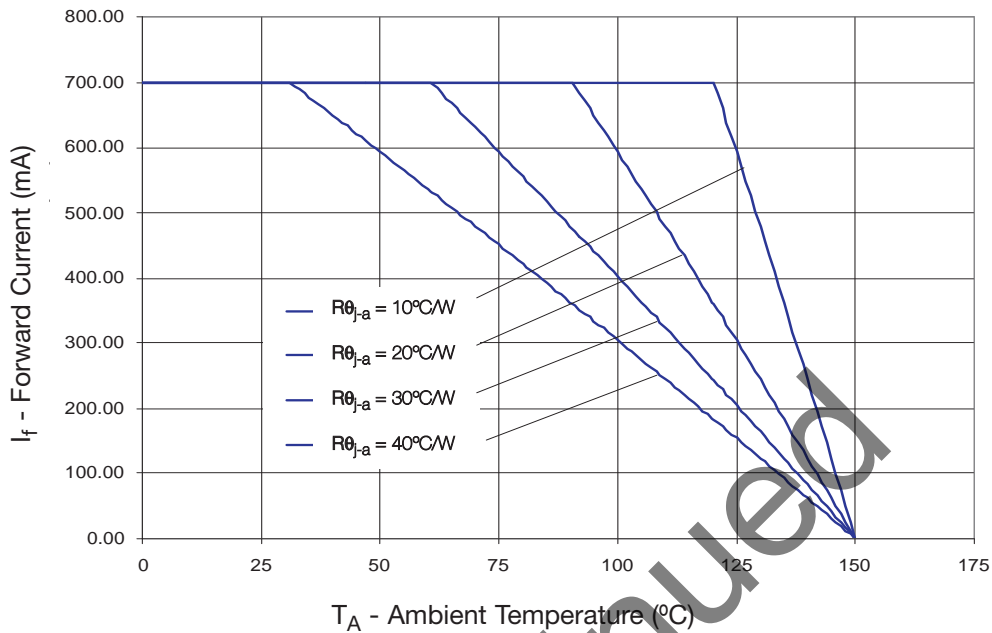

Figure 12: Maximum forward current vs. ambient temperature, based on  $T_{JMAX} = 150^{\circ}\text{C}$ .

### Current Derating Curve for 350 mA Drive Current Cool-White, Neutral-White, Warm-White

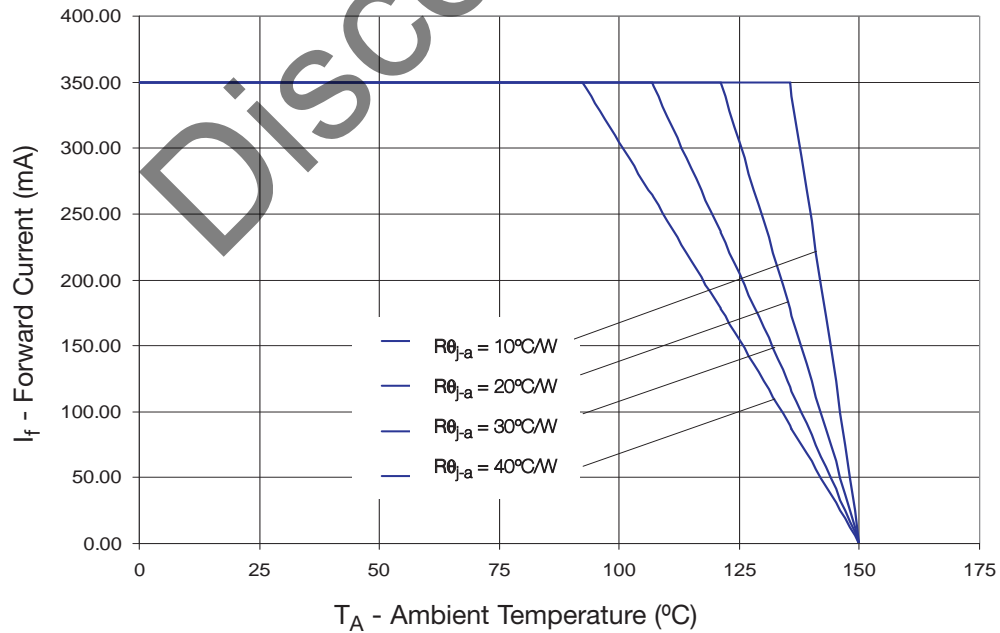

Figure 13: Maximum forward current vs. ambient temperature, based on  $T_{JMAX} = 150^{\circ}\text{C}$ .



## Typical Radiation Patterns

### Typical Representative Spatial Radiation Pattern for White Lambertian

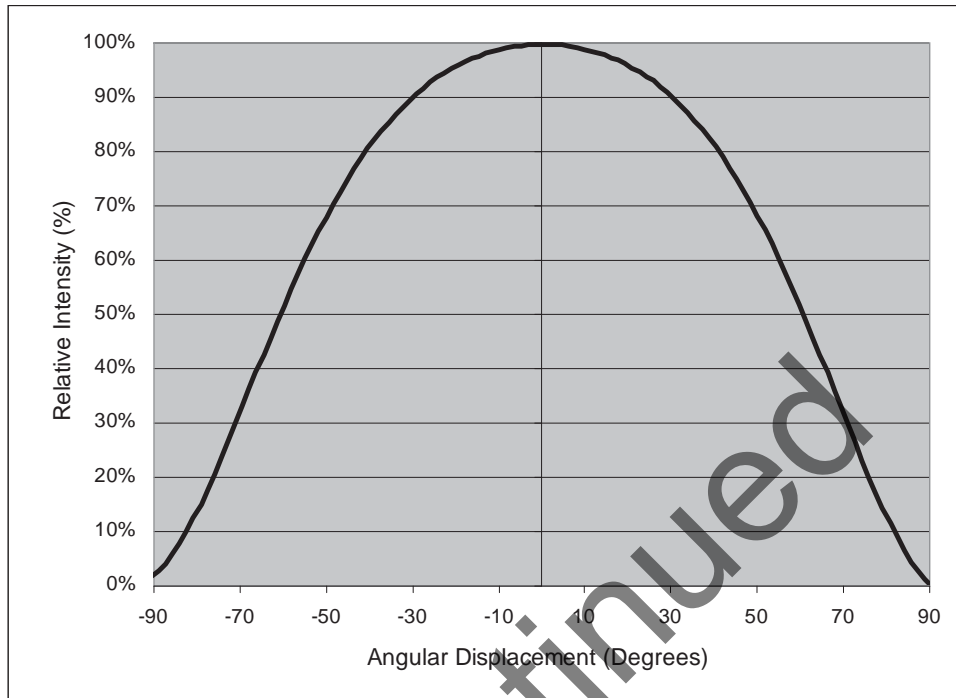

Figure 14: Typical Representative Spatial Radiation Pattern for White Lambertian.

Please contact your Philips Lumileds representative to obtain optimized optical solutions that have been designed for LUXEON K2 with TFFC.

### Typical Polar Radiation Pattern for White Lambertian

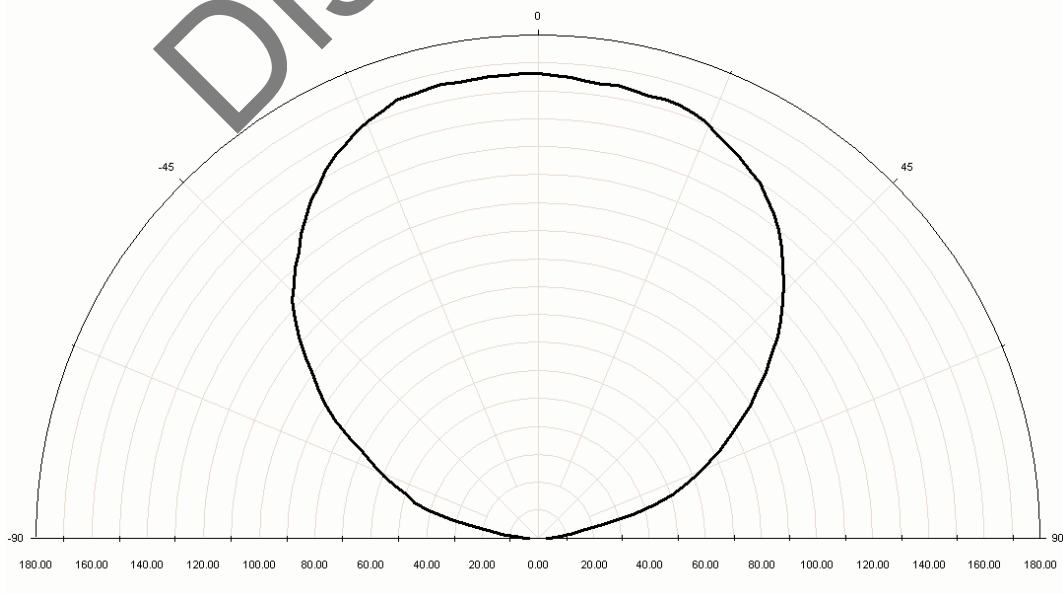
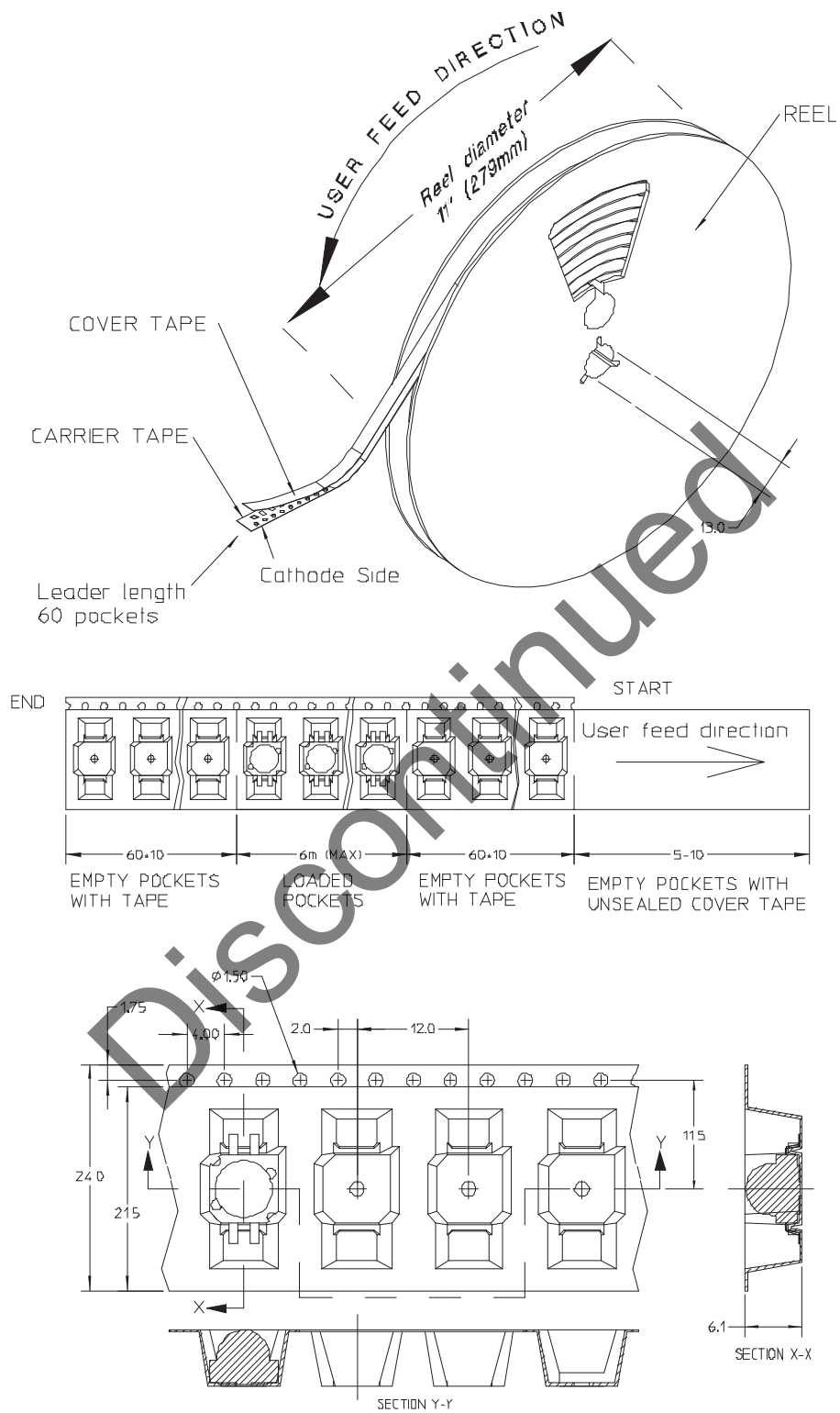

Figure 15: Typical Polar Radiation Pattern for White Lambertian.

# Emitter Reel Packaging



---

## Product Binning and Labeling

### Purpose of Product Binning

In the manufacturing of semiconductor products, there is a variation of performance around the average values given in the technical data sheets. For this reason, Philips Lumileds bins the LED components for luminous flux, color and forward voltage ( $V_F$ ).

### Decoding Product Bin Labeling

LUXEON K2 with TFFC Emitters are labeled using a three or four digit alphanumeric code (CAT code) depicting the bin values for emitters packaged on a single reel. All emitters packaged within a reel are of the same 3-variable bin combination. Using these codes, it is possible to determine optimum mixing and matching of products for consistency in a given application.

### Format of Labeling for Emitters

Reels of Cool-White Emitters are labeled with a four digit alphanumeric CAT code following the format below.

ABCD

A = Flux bin (J, H, J, K etc.)

B and C = Color bin (W0, U0, V0 etc.)

C =  $V_F$  bin (D, E, F, G etc.)

Discontinued

## Luminous Flux Bins

Table 9 lists the standard photometric luminous flux bins for LUXEON K2 with TFFC emitters (at test current).

Although several bins are outlined, product availability in a particular bin varies by production run and by product performance. Not all bins are available in all colors.

**Table 9.**  
**Flux Bins - All Colors (except Royal-Blue)**

Bin Code	Minimum Photometric Flux (lm)	Maximum Photometric Flux (lm)
A	8.2	10.7
B	10.7	13.9
C	13.9	18.1
D	18.1	23.5
E	23.5	30
F	30	40
G	40	50
H	50	60
J	60	70
K	70	80
L	80	90
M	90	100
N	100	120
P	120	140
Q	140	160
R	160	180
S	180	200
T	200	220
U	220	240
V	240	260
W	260	280
X	280	300

Note: Please see Table 1 for binning parameters and tolerances.

## Forward Voltage Bins

Although several bins are outlined, product availability in a particular bin varies by production run and by product performance.

Table 10.

### $V_F$ Bins

Bin Code	Minimum Forward Voltage (V)	Maximum Forward Voltage (V)
A	2.31	2.55
B	2.55	2.79
C	2.79	3.03
D	3.03	3.27
E	3.27	3.51
F	3.51	3.75
G	3.75	3.99
H	3.99	4.23
J	4.23	4.47
K	4.47	4.71

Note: Please see Table 4 for more information on Forward Voltage binning.

Discontinued

## White Binning Information

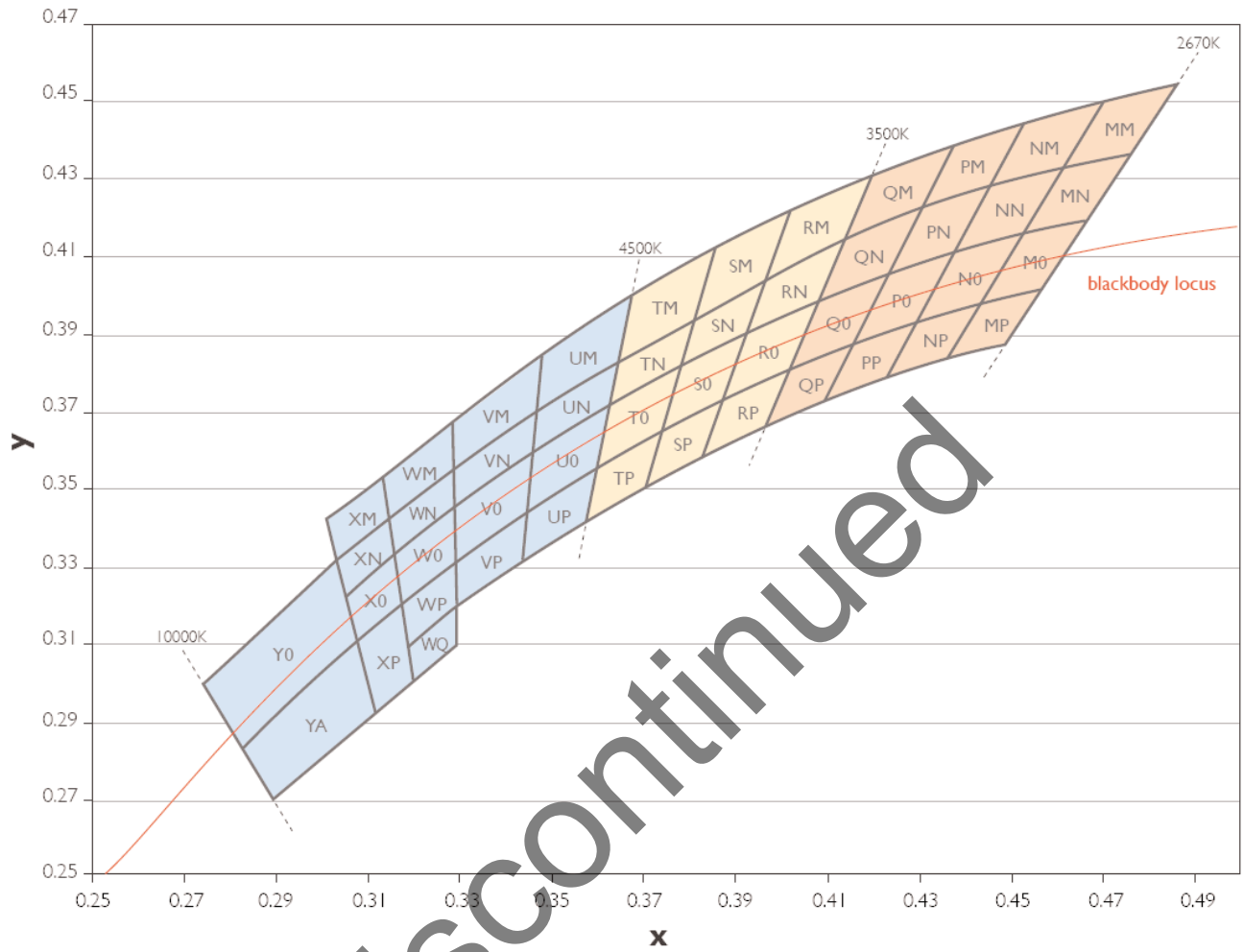

Discontinued

Figure 16: White Binning Structure

# LUXEON K2 with TFFC Cool-White Bin Structure

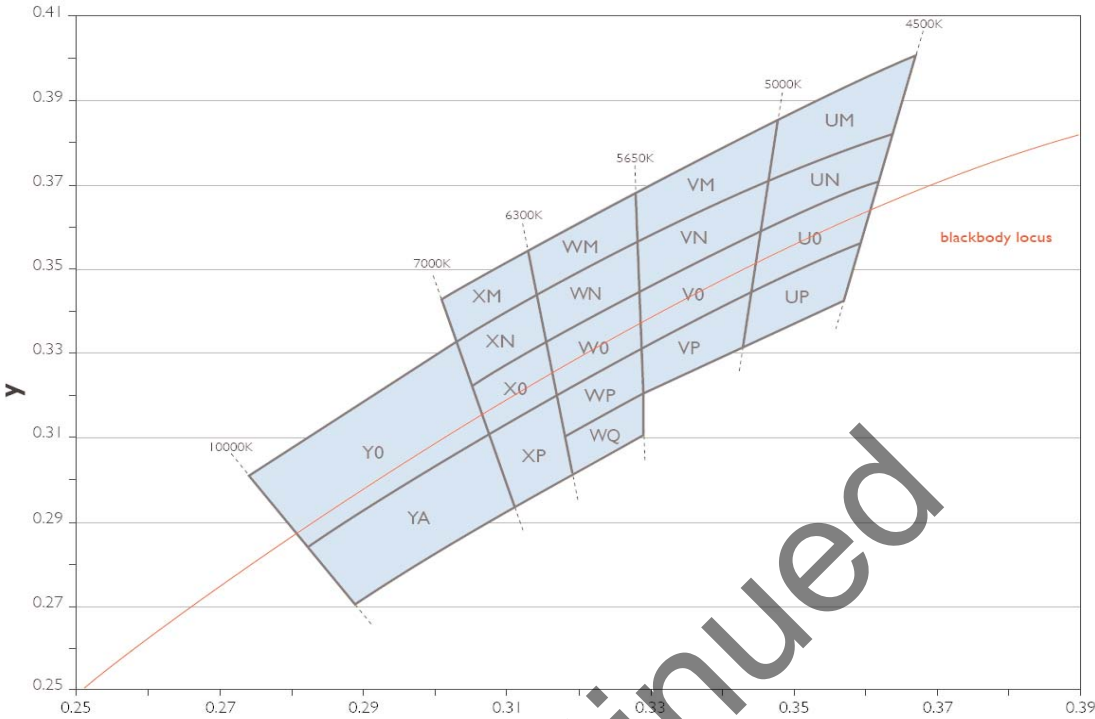

Figure 17: Cool-White Bin Structure

Discontinued

## LUXEON K2 with TFFC Cool-White Bin Structure, Continued

Cool-White LUXEON K2 with TFFC Emitters are tested and binned by x,y coordinates.

19 Color Bins, CCT Range 10,000K to 4,500K

Table 11.

Cool White Bin Structure							
Bin Code	X	Y	Typical CCT (K)	Bin Code	X	Y	Typical CCT (K)
Y0	0.274238	0.300667	8000	WQ	0.318606	0.310201	6000
	0.303051	0.332708			0.329393	0.320211	
	0.307553	0.310778			0.329544	0.310495	
	0.282968	0.283772			0.319597	0.301303	
YA	0.282968	0.283772	8000	VM	0.328636	0.368952	5300
	0.307553	0.310778			0.348147	0.385629	
	0.311163	0.293192			0.346904	0.371742	
	0.289922	0.270316			0.328823	0.356917	
XM	0.301093	0.342244	6700	VN	0.328823	0.356917	5300
	0.313617	0.354992			0.346904	0.371742	
	0.314792	0.344438			0.345781	0.359190	
	0.303051	0.332708			0.329006	0.345092	
XN	0.303051	0.332708	6700	V0	0.329006	0.345092	5300
	0.314792	0.344438			0.345781	0.359190	
	0.316042	0.333222			0.344443	0.344232	
	0.305170	0.322386			0.329220	0.331331	
X0	0.305170	0.322386	6700	VP	0.329220	0.331331	5300
	0.316042	0.333222			0.344443	0.344232	
	0.317466	0.320438			0.343352	0.332034	
	0.307553	0.310778			0.329393	0.320211	
XP	0.307553	0.310778	6700	UM	0.348147	0.385629	4750
	0.317466	0.320438			0.367294	0.400290	
	0.319597	0.301303			0.364212	0.382878	
	0.311163	0.293192			0.346904	0.371742	
WM	0.313617	0.354992	6000	UN	0.346904	0.371742	4750
	0.328636	0.368952			0.364212	0.382878	
	0.328823	0.356917			0.362219	0.371616	
	0.314792	0.344438			0.345781	0.359190	
WN	0.314792	0.344438	6000	U0	0.345781	0.359190	4750
	0.328823	0.356917			0.362219	0.371616	
	0.329006	0.345092			0.359401	0.355699	
	0.316042	0.333222			0.344443	0.344232	
W0	0.316042	0.333222	6000	UP	0.344443	0.344232	4750
	0.329006	0.345092			0.359401	0.355699	
	0.329220	0.331331			0.357079	0.342581	
	0.317466	0.320438			0.343352	0.332034	
WP	0.317466	0.320438	6000				
	0.329220	0.331331					
	0.329393	0.320211					
	0.318606	0.310201					

Note for Table 11:

1. Philips Lumileds maintains a tester tolerance of  $\pm 0.005$  on x, y color coordinates.



## LUXEON K2 with TFFC Neutral-White Bin Structure

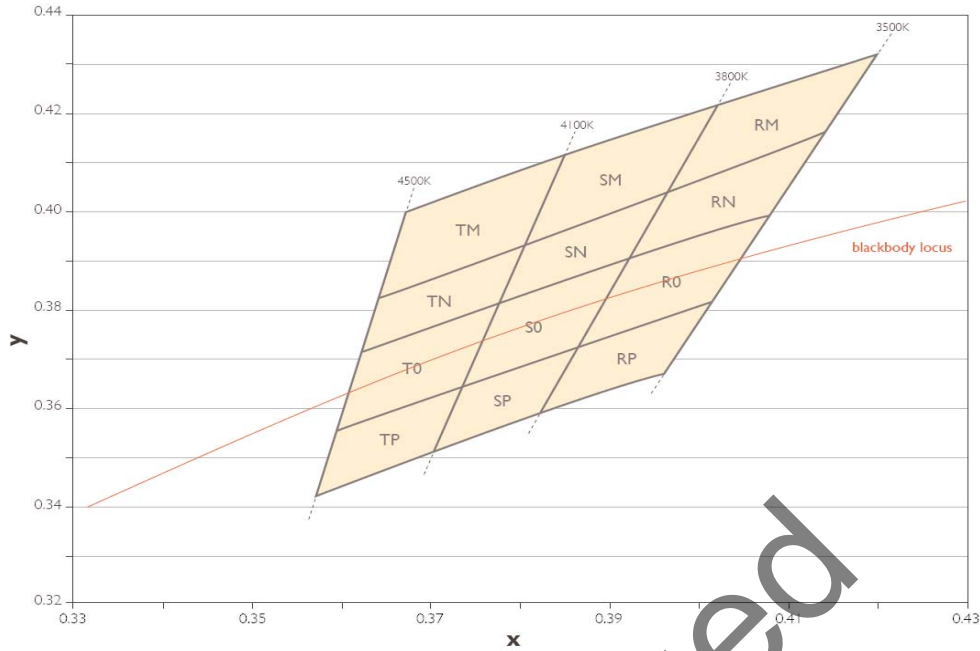

Figure 18: Neutral-White Bin Structure.

Neutral-White LUXEON Rebel Emitters are tested and binned by x,y coordinates. 12 Color Bins, CCT Range 4,500K to 3,500K

Table 12.

Neutral-White Bin Coordinates							
Bin Code	X	Y	Typical CCT (K)	Bin Code	X	Y	Typical CCT (K)
TM	0.367294	0.400290	4300	SO	0.378264	0.382458	3950
	0.385953	0.412995			0.392368	0.390932	
	0.381106	0.393747			0.387071	0.373899	
	0.364212	0.382878			0.374075	0.365822	
TN	0.364212	0.382878	4300	SP	0.374075	0.365822	3950
	0.381106	0.393747			0.387071	0.373899	
	0.378264	0.382458			0.382598	0.359515	
	0.362219	0.371616			0.370582	0.351953	
TO	0.362219	0.371616	4300	RM	0.402270	0.422776	3650
	0.378264	0.382458			0.420940	0.432618	
	0.374075	0.365822			0.414776	0.416097	
	0.359401	0.355699			0.396279	0.403508	
TP	0.359401	0.355699	4300	RN	0.396279	0.403508	3650
	0.374075	0.365822			0.414776	0.416097	
	0.370582	0.351953			0.408593	0.399525	
	0.357079	0.342581			0.392368	0.390932	
SM	0.385953	0.412995	3950	RO	0.392368	0.390932	3650
	0.402270	0.422776			0.408593	0.399525	
	0.396279	0.403508			0.402113	0.382156	
	0.381106	0.393747			0.387071	0.373899	
SN	0.381106	0.393747	3950	RP	0.387071	0.373899	3650
	0.396279	0.403508			0.402113	0.382156	
	0.392368	0.390932			0.396564	0.367284	
	0.378264	0.382458			0.382598	0.359515	

Note for Table 12:

1. Philips Lumileds maintains a tester tolerance of  $\pm 0.005$  on x, y color coordinates.

## LUXEON K2 with TFFC Warm-White Bin Structure

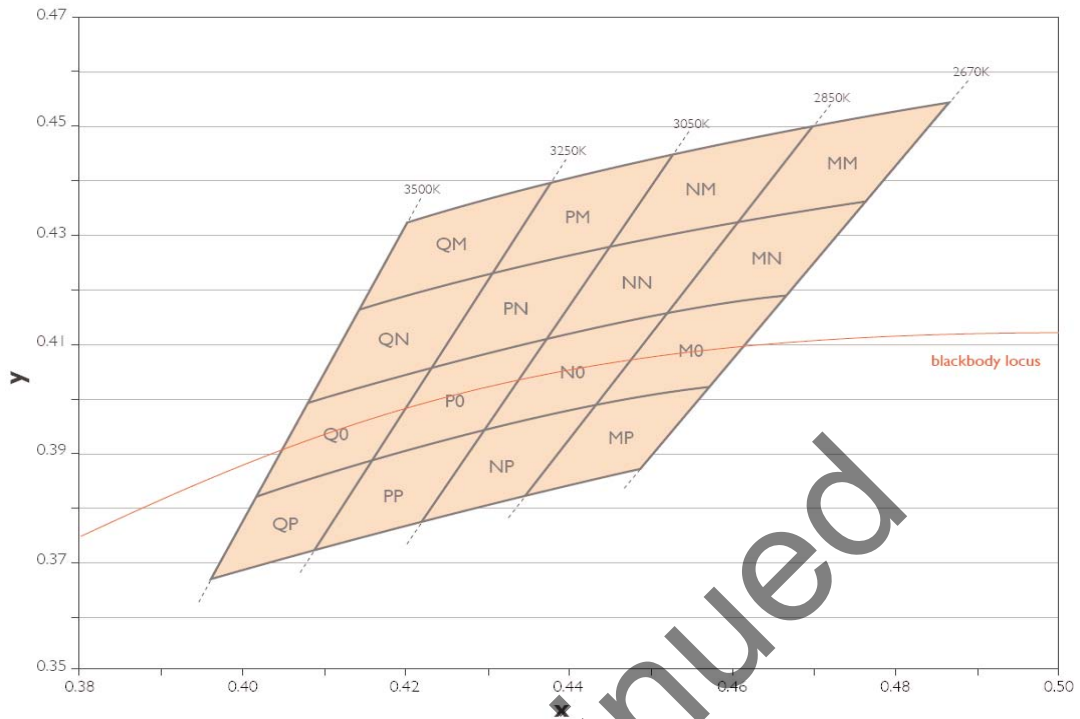

Figure 19: Warm-White Bin Structure.

Discontinued

Warm-White LUXEON Rebel Emitters are tested and binned by x,y coordinates. 15 Color Bins, CCT Range 3,500K to 2,540K

Table 13.

Warm-White Bin Structure							
Bin Code	X	Y	Typical CCT (K)	Bin Code	X	Y	Typical CCT (K)
QM	0.420940	0.432618	3375	NM	0.453820	0.445980	2950
	0.438458	0.440399			0.470507	0.450832	
	0.431186	0.423386			0.461404	0.433334	
	0.414776	0.416097			0.445639	0.428680	
QN	0.414776	0.416097	3375	NN	0.445639	0.428680	2950
	0.431186	0.423386			0.461404	0.433334	
	0.423956	0.406472			0.452512	0.416241	
	0.408593	0.399525			0.437578	0.411632	
QO	0.408593	0.399525	3375	NO	0.437578	0.411632	2950
	0.423956	0.406472			0.452512	0.416241	
	0.416487	0.389001			0.443600	0.399111	
	0.402113	0.382156			0.429373	0.394281	
QP	0.402113	0.382156	3375	NP	0.429373	0.394281	2950
	0.416487	0.389001			0.443600	0.399111	
	0.409996	0.373814			0.435591	0.383714	
	0.396564	0.367284			0.422124	0.378952	
PM	0.438458	0.440399	3150	MM	0.470507	0.450832	2760
	0.453820	0.445980			0.486648	0.454191	
	0.445639	0.428680			0.476733	0.436634	
	0.431186	0.423386			0.461404	0.433334	
PN	0.431186	0.423386	3150	MN	0.461404	0.433334	2760
	0.445639	0.428680			0.476733	0.436634	
	0.437578	0.411632			0.467132	0.419632	
	0.423956	0.406472			0.452512	0.416241	
PO	0.423956	0.406472	3150	MO	0.452512	0.416241	2760
	0.437578	0.411632			0.467132	0.419632	
	0.429373	0.394281			0.457663	0.402866	
	0.416487	0.389001			0.443600	0.399111	
PP	0.416487	0.389001	3150	MP	0.443600	0.399111	2760
	0.429373	0.394281			0.457663	0.402866	
	0.422124	0.378952			0.448994	0.387515	
	0.409996	0.373814			0.435591	0.383714	

Note for Table 13:

1. Philips Lumileds maintains a tester tolerance of  $\pm 0.005$  on x, y color coordinates.

---

# PHILIPS LUMILEDS

## Company Information

Philips Lumileds is the world's leading provider of power LEDs for everyday lighting applications. The company's records for light output, efficacy and thermal management are direct results of the ongoing commitment to advancing solid-state lighting technology and enabling lighting solutions that are more environmentally friendly, help reduce CO<sub>2</sub> emissions and reduce the need for power plant expansion. Philips Lumileds LUXEON® LEDs are enabling never before possible applications in outdoor lighting, shop lighting and home lighting.

Philips Lumileds is a fully integrated supplier, producing core LED material in all three base colors, (Red, Green, Blue) and white. Philips Lumileds has R&D centers in San Jose, California and in the Netherlands, and production capabilities in San Jose, Singapore and Penang Malaysia. Founded in 1999, Philips Lumileds is the high flux LED technology leader and is dedicated to bridging the gap between solid-state technology and the lighting world. More information about the company's LUXEON LED products and solid-state lighting technologies can be found at [www.philipslumileds.com](http://www.philipslumileds.com).

Philips Lumileds may make process or materials changes affecting the performance or other characteristics of our products. These products supplied after such changes will continue to meet published specifications, but may not be identical to products supplied as samples or under prior orders.



[WWW.LUXEON.COM](http://WWW.LUXEON.COM)

[WWW.FUTURELIGHTINGSOLUTIONS.COM](http://WWW.FUTURELIGHTINGSOLUTIONS.COM)

FOR TECHNICAL ASSISTANCE OR THE LOCATION OF YOUR NEAREST SALES OFFICE CONTACT ANY OF THE FOLLOWING:

NORTH AMERICA:

1 888 589 3662

[AMERICAS@FUTURELIGHTINGSOLUTIONS.COM](mailto:AMERICAS@FUTURELIGHTINGSOLUTIONS.COM)

EUROPE:

00 800 443 88 873

[EUROPE@FUTURELIGHTINGSOLUTIONS.COM](mailto:EUROPE@FUTURELIGHTINGSOLUTIONS.COM)

ASIA PACIFIC:

800 5864 5337

[ASIA@FUTURELIGHTINGSOLUTIONS.COM](mailto:ASIA@FUTURELIGHTINGSOLUTIONS.COM)

JAPAN:

800 5864 5337

[JAPAN@FUTURELIGHTINGSOLUTIONS.COM](mailto:JAPAN@FUTURELIGHTINGSOLUTIONS.COM)